



Cross Primary Teacher's Packet

<i>Title of Poster</i>	<i>To be Used in Session</i>	Items that are noted as “In File” appear as such and may be printed. <i>Other items from the Teacher’s Packet were originally printed with permission from outside sources. The permission to print has been discontinued. We have provided links so that classes may view these online.</i>
UNIT I		
Psalms 78:1-4	I.1	In File
Story medallions: Amos	I.1	In File
Story medallions: Isaiah	I.2	In File
Peaceable Kingdom	I.2	In File
Story medallions: Daniel	I.3	In File
Daniel and the Lions	I.3	In File
Story medallions: Elijah	I.4	In File
Story medallions: Jeremiah	I.5	In File
Story medallions: Jonah	I.6	In File
Story medallions: Nehemiah and Ezra	I.7	In File
Story medallions: Esther	I.8	In File

Unit II		
Seasonal Ornaments	II.1-5	In File
Song of Simeon (Nunc Dimittis)	II.5	In File
Sanctus	II.6-9	In File
Sermon on the Mount	II.6	In File
Peace Symbol	II.7	In File
Children Praying	II.8	In File
UNIT III		
Confession of Sin	III.1-7	In File
Bishop	III.2	In File
Bishop's Mitre	III.2	In File
Priest	III.3	In File
Deacon	III.4	In File
Ushers	III.5	In File
Gladness Plaque	III.5	In File
Jesus in the Wilderness	III.6	In File
Palm Sunday	III.7	In File
UNIT IV		
A Prayer of St. Francis	IV.1-9	In File
Saint's Sun catcher's		
Agnes	IV.1	In File
Athanasius	IV.2	In File
Patrick	IV.3	In File
Benedict	IV.4	In File
Hilda	IV.5	In File
Celtic Cross	IV.5	In File
Monastery	IV.5	http://www.geocities.com/paintedchurches/images/SUCEVITA-MONASTERY4.jpg

Franics	IV.6	In File
Clare	IV.7	In File
Julian	IV.8	In File
Medieval town	IV.8	http://www.igshistoryonline.co.uk/Images/Medieval%20Town.jpg
Pentecost	IV.9	In File

Confession of Sin

Most merciful God,
we confess that we have sinned against you
in thought, word, and deed,
by what we have done,
and by what we have left undone.
We have not loved you with our whole heart;
we have not loved our neighbors as ourselves.
We are truly sorry and we humbly repent.
For the sake of your Son Jesus Christ,
have mercy on us and forgive us;
that we may delight in your will,
and walk in your ways,
to the glory of your Name. *Amen.*





*Serve the Lord
with gladness!*

Gladness Plaque III.5

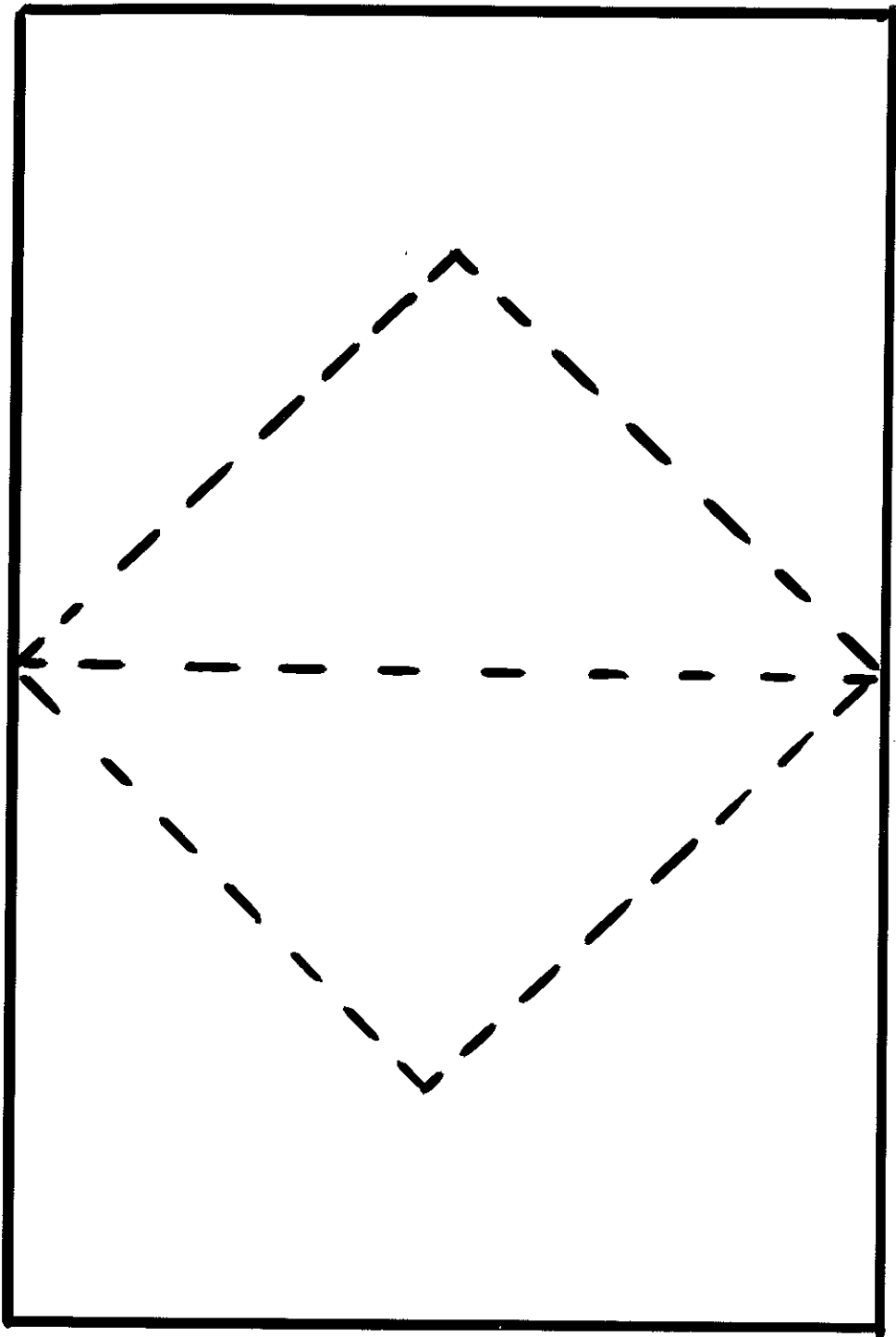

Bishop's Mitre III.2

Mitre instructions:

Cut along solid lines, and fold along dotted lines to create a mitre.









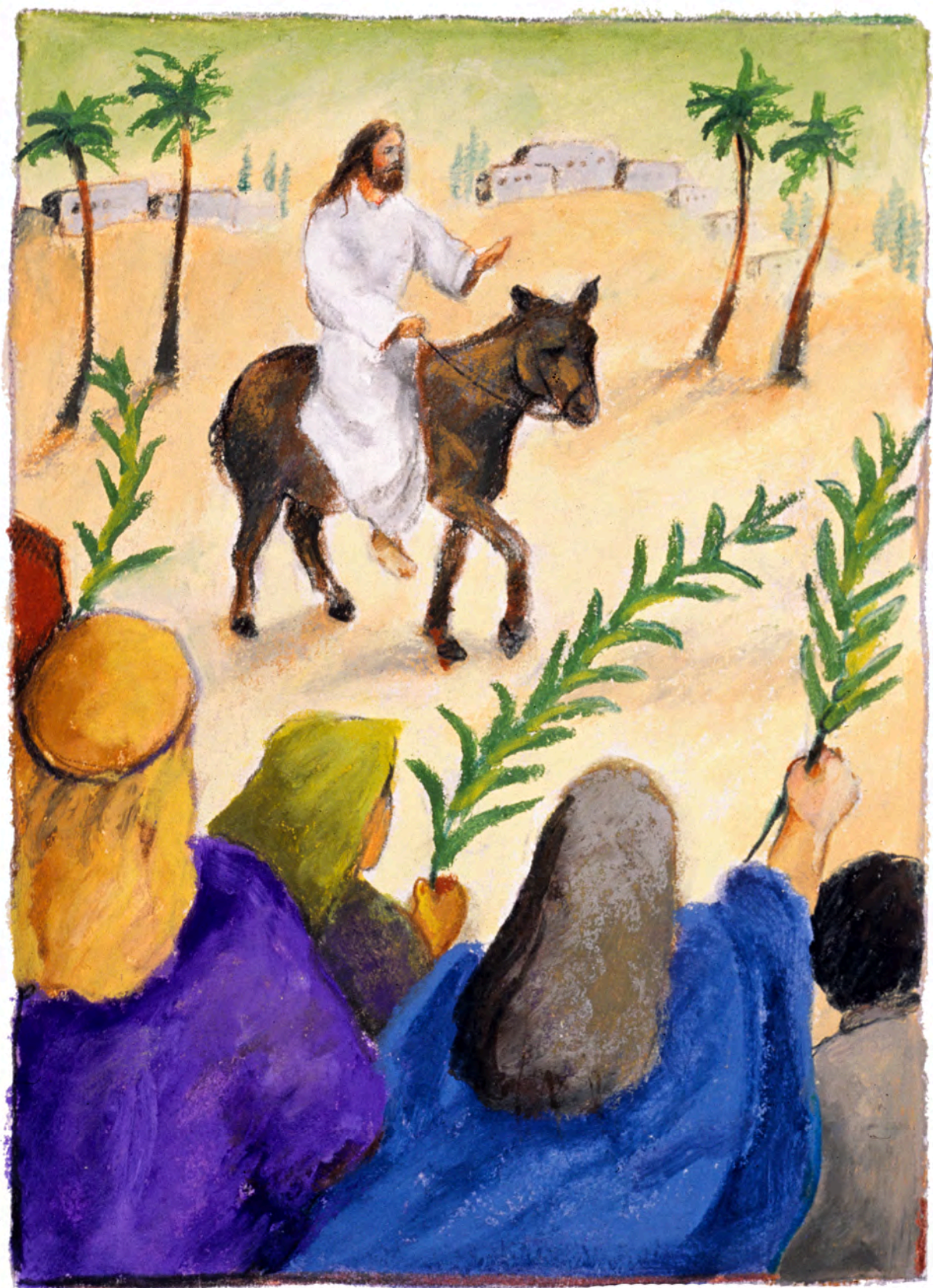

IV.1

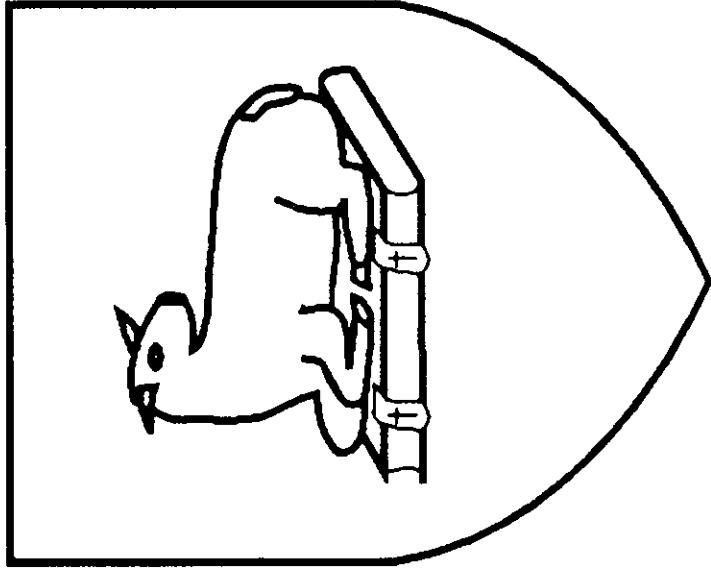

Saint Agnes

IV.2

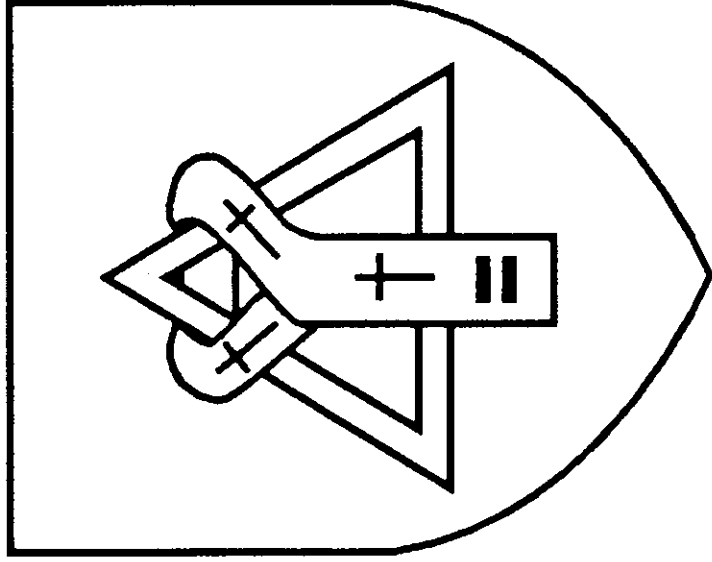

Saint Athanasius

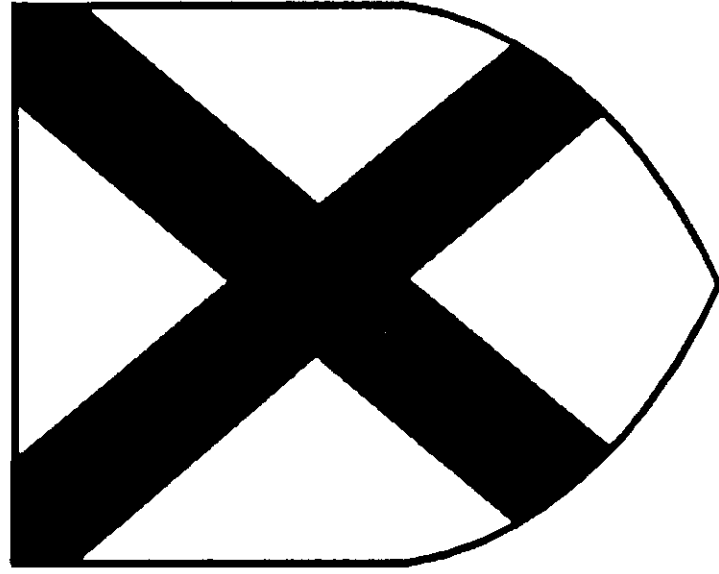

Saint Patrick

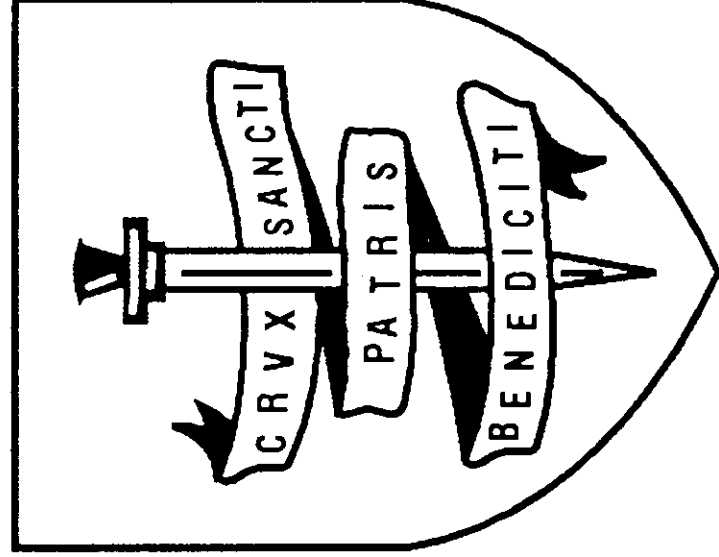

Saint Benedict



A Prayer attributed to St. Francis

**Lord, make us instruments of your peace.
Where there is hatred, let us sow love;
where there is injury, pardon;
where there is discord, union;
where there is doubt, faith;
where there is despair, hope;
where there is darkness, light;
where there is sadness, joy.**

**Grant that we may not so much seek
to be consoled as to console;
to be understood as to understand;
to be loved as to love.**

**For it is in giving that we receive;
it is in pardoning that we are pardoned;
and it is in dying that we are born to eternal
life. *Amen.***

The Book of Common Prayer, page 833



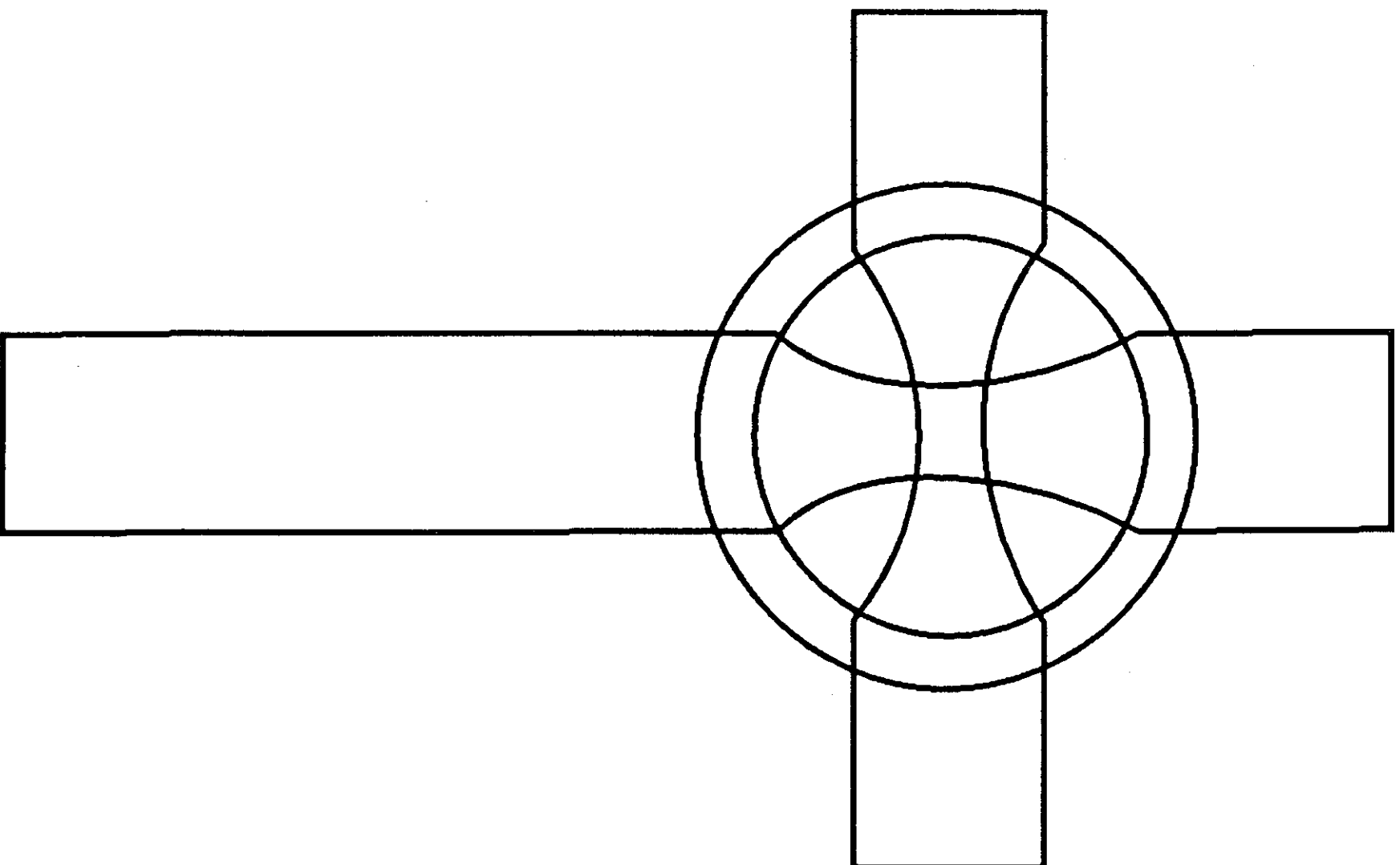

Celtic Cross

IV.5



IV.5

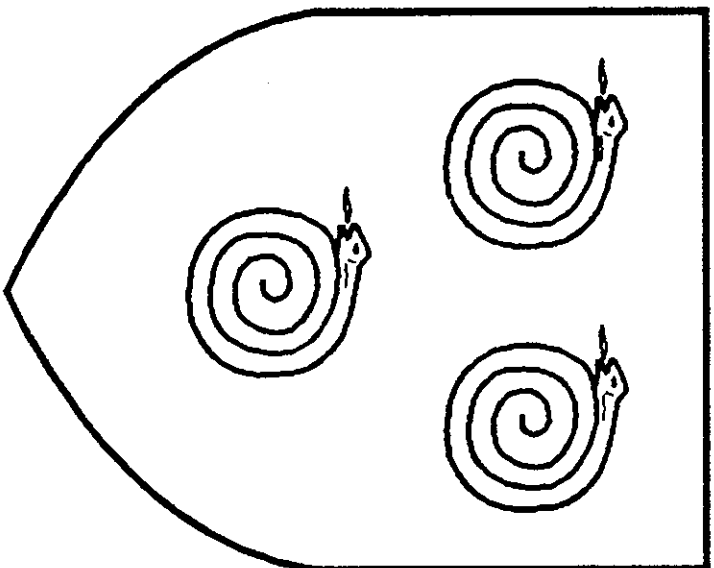

Saint Hilda

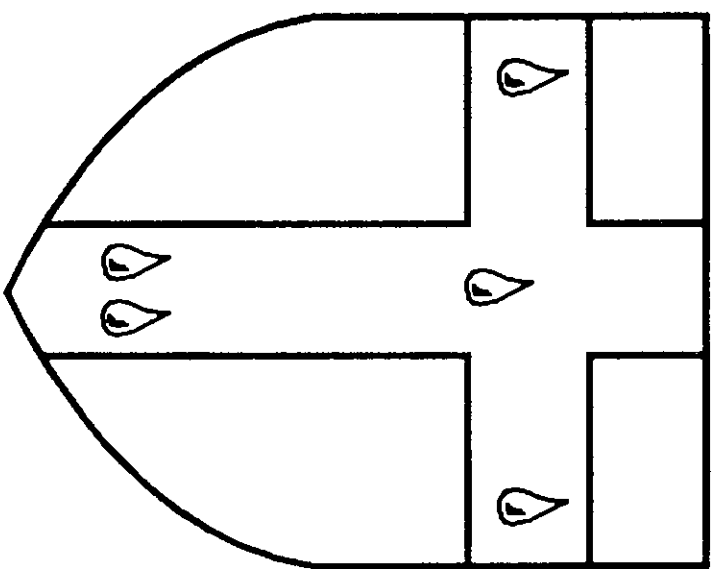

Saint Francis

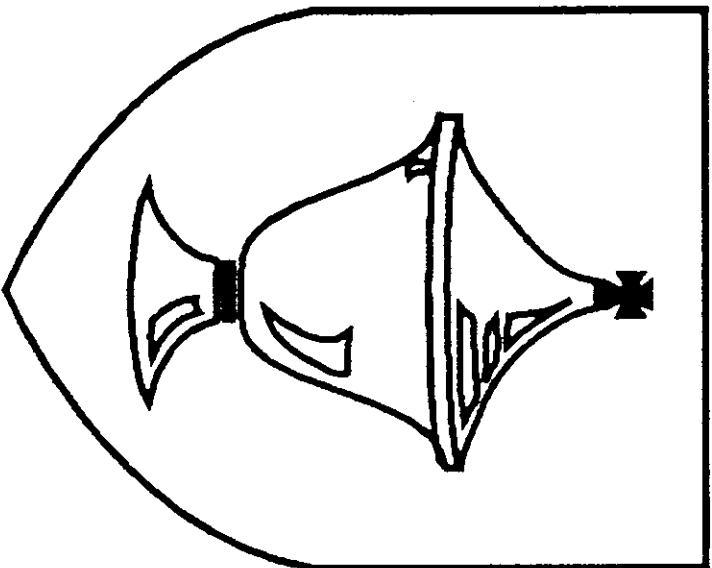

Saint Clare

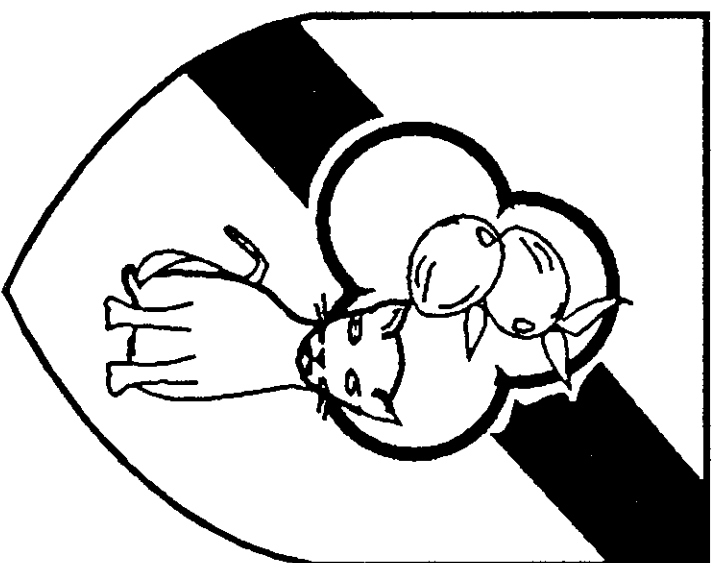

Saint Julian

IV.7

IV.8



B. Tull
93c